



DATASHEET APVSG Specification V1.14

Ultra-Agile Vector Signal Generator

10 MHz to 4, 6, 20, and 40 GHz



Document size:

1 title page
20 content pages

DEFINITIONS

The specifications in the following pages describe the warranted performance of the instrument for 23 ± 5 °C after a 30-minute warm-up period

Typical: Expected mean values, not warranted performance

Min and max: Parameter range that is guaranteed by product design, and/or production tested. Warranted performance specifications include guard-bands to account for the expected statistical performance distribution, measurement uncertainties, and changes in performance due to environmental conditions.

INTRODUCTION

Ultra-Agile Vector Signal Generator

The APVSG is an ultra-fast-switching vector-modulated signal source covering a continuous frequency ranges from 10 MHz to 4, 6, 20, or 40 GHz, respectively, with 0.001 Hz resolution, and 500 MHz RF modulation bandwidth.

The standard APVSG enables ultra-fast CW frequency sweeping, chirping, intra-pulse modulation, pulse shaping with very low phase noise.

A high performance internal I/Q modulator enables customized modulation waveforms and supports dedicated modulation schemes including avionics modulation.

All APVSGs operate with ultra-stable temperature compensated frequency reference (OCXO) ensuring minimal drift, and can be phase-locked to an external reference.

The compact unit allows for full front panel control via touch panel display, and PC GUI Software supported operation via ETHERNET, USB or GPIB communication ports.

The following options are supported:

- **PE4:** Electrical step attenuator
- **LN:** Improved close-in phase noise behavior
- **UFS:** Ultra-fast switching
- **VREF:** Programmable external reference
- **AVIO:** Avioniques modulations (DME, ILS, VOR, ...)
- **FCP:** Fast control port for parallel programming
- **EIQ:** External I/Q inputs
- **MOD:** Analog modulations

FACTS & FIGURES & SPECIFICATIONS

Signal Specifications

PARAMETER	MIN	TYPICAL	MAX	NOTE
Frequency Range	10 MHz		4 GHz 6 GHz 20 GHz 40 GHz	APVSG04 APVSG06 APVSG20 APVSG40
Frequency Resolution		0.001 Hz		
Phase Resolution		0.01 deg		
Frequency & Amplitude Switching / Settling Time		1.5 ms 500 μ s 200 ns 800 ns		valid signal after SCPI received List sweep 500 MHz BW, Option UFS any step Option UFS
Output Power Level				
0.01 to 4 GHz	-65 dBm		+15 dBm	
4 to 6 GHz	-20 dBm		+20 dBm	
6 to 20 GHz	-20 dBm		+18 dBm	
20 to 40 GHz	-20 dBm		+15 dBm	
Output Power Level (Option PE4)				
4 to 6 GHz	-90 dBm		+10 dBm	
6 to 20 GHz	-60 dBm		+13 dBm	
20 to 40 GHz	-50 dBm		+10 dBm	
Power Resolution		0.01 dB		
Power Level Uncertainty				Digital ALC on, -20dBm to Pmax
<4 GHz		0.25 dB	1.2 dB	
4 to 6 GHz		0.3 dB	1.3 dB	
6 to 20 GHz		0.3 dB	1.6 dB	
20 to 40 GHz			2.0 dB	
Reverse Power Protection				
DC Voltage			\pm 10 V	
RF Power			26 dBm	
Output Impedance		50 Ω		
VSWR		1.8		See measurement Figure 3
SSB Phase Noise at 1 GHz and 10 dBm				See measurement Figure 1, 2
at 10 Hz from carrier		-87 dBc/Hz -100 dBc/Hz		Option LN
at 1 kHz from carrier		-130 dBc/Hz		
at 20 kHz from carrier		-145 dBc/Hz		
at 100 kHz from carrier		-150 dBc/Hz		
SSB Phase Noise at 4 GHz and 10 dBm				See measurement Figure 1, 2
at 10 Hz from carrier		-74 dBc/Hz -90 dBc/Hz		Option LN
at 1 kHz from carrier		-121 dBc/Hz		
at 20 kHz from carrier		-133 dBc/Hz		
at 100 kHz from carrier		-138 dBc/Hz		
SSB Phase Noise at 10 GHz and 10 dBm				See measurement Figure 1, 2
at 10 Hz from carrier		-67 dBc/Hz -80 dBc/Hz		Option LN
at 1 kHz from carrier		-113 dBc/Hz		
at 20 kHz from carrier		-124 dBc/Hz		
at 100 kHz from carrier		-130 dBc/Hz		
SSB Phase Noise at 40 GHz and 10 dBm				See measurement Figure 1, 2
at 10 Hz from carrier		-55 dBc/Hz -68 dBc/Hz		Option LN
at 1 kHz from carrier		-101 dBc/Hz		
at 20 kHz from carrier		-112 dBc/Hz		
at 100 kHz from carrier		-118 dBc/Hz		
Harmonics (at 0 dBm output)		-40 dBc -50 dBc	-45 dBc -50 dBc	< 0.5 GHz 0.5 to 4 GHz

		-55 dBc tbd tbd	tbd tbd	4 to 6 GHz 6 to 20 GHz 20 to 40 GHz
Sub-Harmonics (at 0 dBm output)		-75 dBc tbd tbd		< 6 GHz 6 to 20 GHz > 20 GHz
Non-Harmonic Spurious (at 0 dBm output, > 10 kHz offset)		-90 dBc -92 dBc -90 dBc -84 dBc -80 dBc -70 dBc	-85 dBc -88 dBc -86 dBc -80 dBc -74 dBc -66 dBc	< 1.2 GHz 1.2 to 2.5 GHz 2.5 to 5 GHz 10 to 10 GHz 10 to 20 GHz > 20 GHz



Modulation Capability (Digital)

PARAMETER	MIN	TYPICAL	MAX	NOTE
I/Q Modulator				
RF modulation bandwidth		400 MHz		
Carrier leakage		< -70 dBc		
Image sideband rejection		< -65 dBc		
Internal I/Q Baseband Generator	1 channel for I and Q	Arbitrary data from memory		
Resolution		16 bits		For I and Q each
Waveform clock (sample rate)		500 MHz		
Resolution		0.1 Hz		
Aliasing filter				
Accuracy		Same as time base		
Triggering		See trigger section		
Marker signals		Up to 3		
Operating modes				
Waveform Segments	1		1024	
Waveform sequencer playlist	1		2048	
Trigger modes	Same segment, next segment			
Waveform Memory for Playback		125 MSa 250 MSa		Optional
External analog I/Q Data Inputs				Option EIQ, rear I and Q inputs (BNC female)
Analog bandwidth	DC		100 MHz	
Voltage range	-0.5 V		0.5 V	
Input impedance		50 R		
Full scale voltage		0.5Vrms		$\sqrt{I^2+Q^2}$
Multicarrier generation				
Number of carriers	1		1024	

Frequency offset	-200 MHz		200 MHz	
Power offset	-60 dB		0 dB	0.1 dB resolution
Tone initial phase offset	0 deg		360 deg	0.1 deg resolution
Internal modulation supported	ASK, PSK, N-FSK; QAM			Option IVM
ASK depth	0 %		100 %	0.1 % resolution
FSK deviation	10 Hz		200 MHz	0.1 Hz resolution
Symbol rate	100 Hz		100 MHz	

AVIO Modulation

AVIO Modulation DME				
Operating modes	interrogation & reply			
DME channel	X, Y			
Frequency range	960 MHz		1215 MHz	
Pulse on/off ratio		80 dB	70 dB	
Pulse rise/fall times	100 ns		50 us	100 ns resolution
Pulse width	100 ns		100 us	100 ns resolution
Pulse spacing	100 ns		300 us	100 ns resolution
Pulse rate	10 Hz		10 kHz	1 Hz resolution
Pulse shaping	cos, cos ² linear, gauss			individually settable for rising & falling edge
ID code				
ID rate				
AVIO Modulation VOR	108 to 118 MHz			
Bearing accuracy		±2% / ±0.5 deg		
Subcarrier frequency accuracy		9960 ± 2 Hz		
AM accuracy		30 ± 1%		
AM distortion (THD)			2%	
FM accuracy		480 ± 1 Hz		
AVIO Modulation ILS	108 MHz		112 MHz	
AM accuracy		40 ± 1%		
AM distortion				
DDM resolution		0.0002 0.0004		Localizer Glide Slope
DDM accuracy		0.0004 0.0008		Localizer Glide Slope
Marker Beacon				
AM tone accuracy (95% AM)		5% of setting		
AM tone distortion (95% AM)		5%		



Modulation Capability (Analog)

PARAMETER	MIN	TYPICAL	MAX	NOTE
Pulse Modulation				
Modulation source		Internal / External		
Pulse rise/fall time		5 ns		10% / 90% of amplitude

On/off ratio		80 dB 75 dB	70 dB 60 dB	< 5.5 GHz elsewhere
Pulse overshoot			1 dB	
Pulse Repetition Frequency (PRF)	0.1 Hz		100 MHz	= 1/T
Minimum pulse settling range	10 ns		20 s	
Pulse Pattern Modulation & Staggered PRF				Using internal pattern generator
Programmable pattern length	2		65536	
Duty cycle	0.05%		99.95%	In 0.05% step
Pulse width resolution		2 ns		
Pulse period (T) accuracy		same as timebase		
Pulse width accuracy		same as timebase		
Pulse jitter			1 ns	
Polarity		selectable		
Amplitude Modulation				
Modulation source		Internal / External		External requires option EIQ
Modulation depth	0%		100%	Output is clipped at max power level
Deviation accuracy		0.5%	2%	1 kHz rate, 30% depth
Deviation resolution		0.1%		
Distortion (THD)			1%	1 kHz rate, 30% depth
Modulation frequency range	DC		100 MHz	
Modulation waveforms		Sine, Square		
Frequency Modulation				
Modulation source		Internal / External		External requires option EIQ
Maximum frequency deviation (peak)		400 MHz		
Deviation accuracy		0.5%	1%	
Distortion (THD)		< 1 %		1 kHz rate, 10 kHz deviation
Modulation frequency range	0.1 Hz		100 MHz	
Modulation waveforms		Sine, square		
Phase Modulation				
Modulation source		Internal / External		External requires option EIQ
Phase deviation (peak)	0		300 rad	
Deviation accuracy		0.5%	1%	
Modulation frequency range	0.1 Hz		100 MHz	
Modulation waveforms		Sine		
Distortion (THD)		< 1%		1 kHz rate & N x rad deviation



Frequency Reference

PARAMETER	MIN	TYPICAL	MAX	NOTE
Internal Reference Frequency		100 MHz 10 MHz		Option LN
Initial calibrated accuracy			±20 ppb	At 23 ± 3 °C
Temperature stability			±100 ppb ±30 ppb	0 to 50 °C Option LN
Aging after 1st year			1 ppm 0.3 ppm	Option LN
Aging per day			5 ppb	after 30 days operation

			0.5 ppb	Option LN
Warm-up time		5 min		
Output of internal reference		100 MHz		
		10/100 MHz		Option LN
Output power		0 dBm		
Output impedance		50 Ω		
Bypass Internal reference Input		100 MHz		High phase synchronous mode
Phase Lock to External Reference		10 MHz integer MHz 100 MHz	250	Option VREF
Bypass Mode	5			
Reference input level				
10 MHz or 1-250 MHz	-5 dBm	0 dBm	+10 dBm	
100 MHz	5 dBm		+15 dBm	
Lock Range				
10 MHz or 1-250 MHz			±1.5 ppm	
100 MHz			>100 ppm	
Reference input impedance		50 Ω		

Sweeping Capability

PARAMETER	MIN	TYPICAL	MAX	NOTE
Sweep Type	List, linear, logarithmic, sawtooth, triangle, random			
Frequency Sweep Range	Full range			
Sweep Parameters	Frequency, power, phase			
Step time (t_{step})	500 μs 200 ns 800 ns		19998 s 19998 s	Option UFS, within +/- 225 MHz Option UFS, Freq step > +/- 225 MHz
Settling time (t_{inv})				To stabilize phase and amplitude, depends on frequency step
Trigger latency (t_{de})		10 ns		Time from trigger to initiate signal transient
Time resolution		2 ns		
Timing accuracy per point		2 ns		

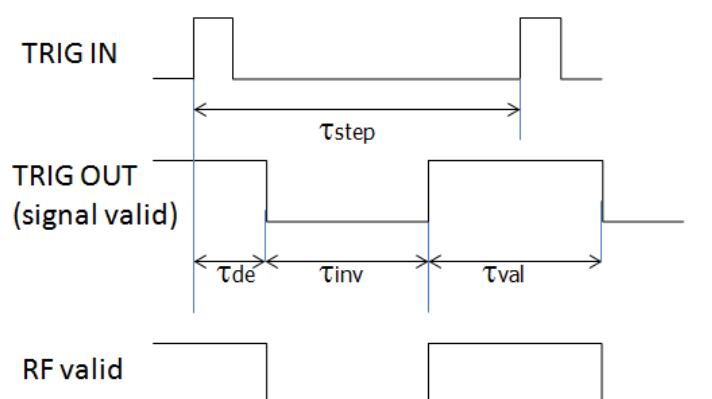

Trigger Capability

PARAMETER	MIN	TYPICAL	MAX	NOTE
Trigger Types	Continuous, single (point), gated, gated direction			
Trigger Source	External (TRIG1/2), bus (LAN, USB)			
Trigger Modes	Continuous free run (AUTO), trigger and run, reset and run			
Trigger latency		10 ns		

Trigger uncertainty		2 ns		
External trigger delay	0		10 s	Settable
External delay resolution		2 ns		
Trigger Polarity	Rising, falling			



Fast Control Port (Option FCP)

Parallel hardware interface for high speed programming using PDW (Pulse descriptor words) or for external digital or analog (option EIQ) IQ data input

Mode	Normal or Stream
Interface	LVDS
Sampling Rate	125 MHz
Latency	80 ns
Input	40 bits data 6 bits address 1 bit strobe
Output	3 bits trigger / marker
Connector Type	Mini D-type, 100 pin
Normal Mode	Frequency / Amplitude / Phase
Stream	32 bits I/Q data

TYPICAL PERFORMANCE CURVES

Figure 1: SSB Phase Noise Performance, CW with option LN, Pout=10 dBm

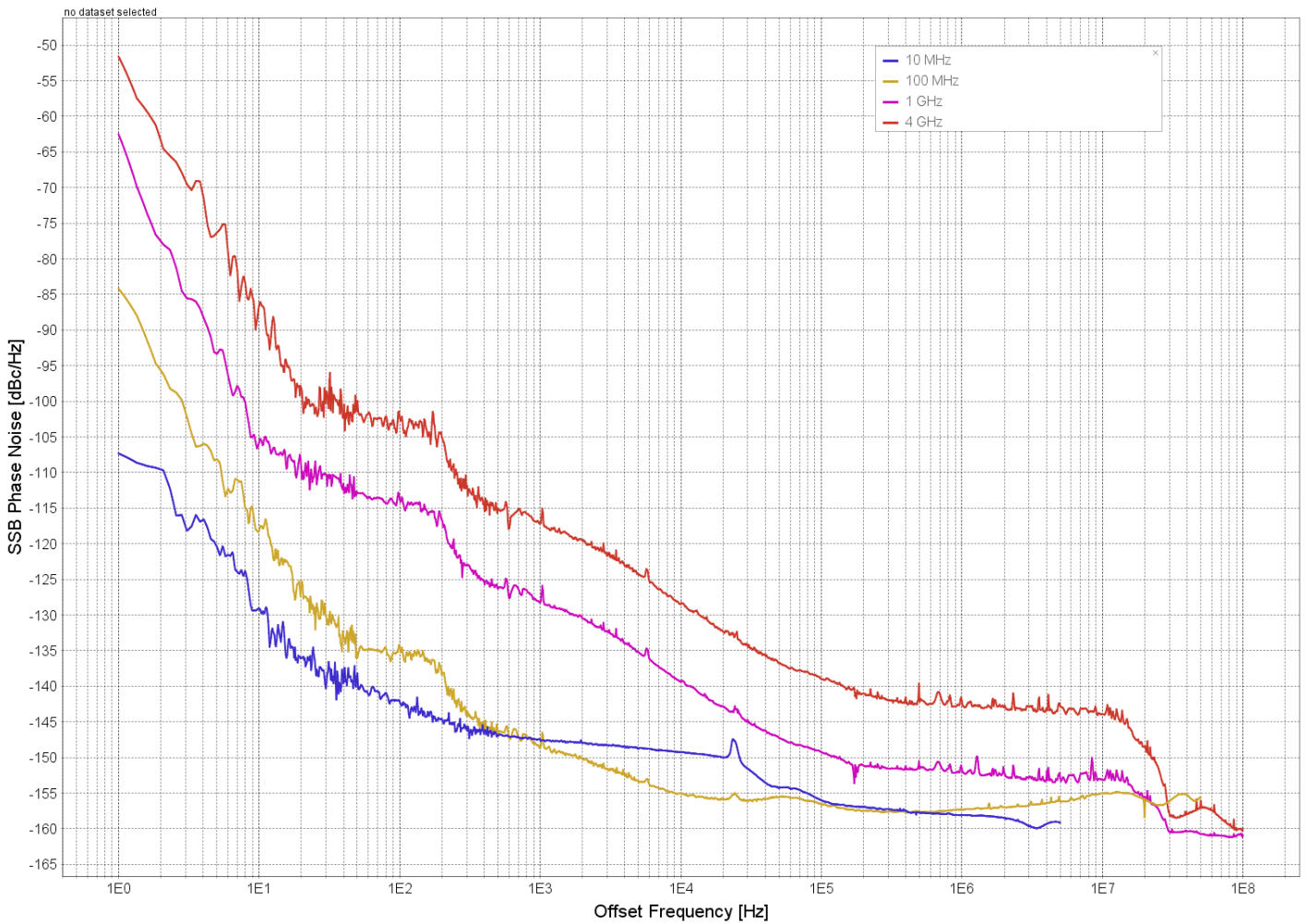

Offset → RF ↓	1 Hz	10 Hz	100 Hz	1 kHz	10 kHz	100 kHz	1 MHz	floor
10 MHz		-133	-141	-149	-150	-156	-158	-158
100 MHz		-119	-135	-148	-155	-156	-158	-159
1 GHz		-100	-114	-129	-140	-150	-152	-160
2 GHz		-93	-108	-124	-135	-145	-146	-155
4 GHz		-87	-102	-118	-129	-139	-140	-151
6 GHz								
10 GHz								
20 GHz								

Figure 2: Amplitude Noise, 2 GHz, Pout=10 dBm

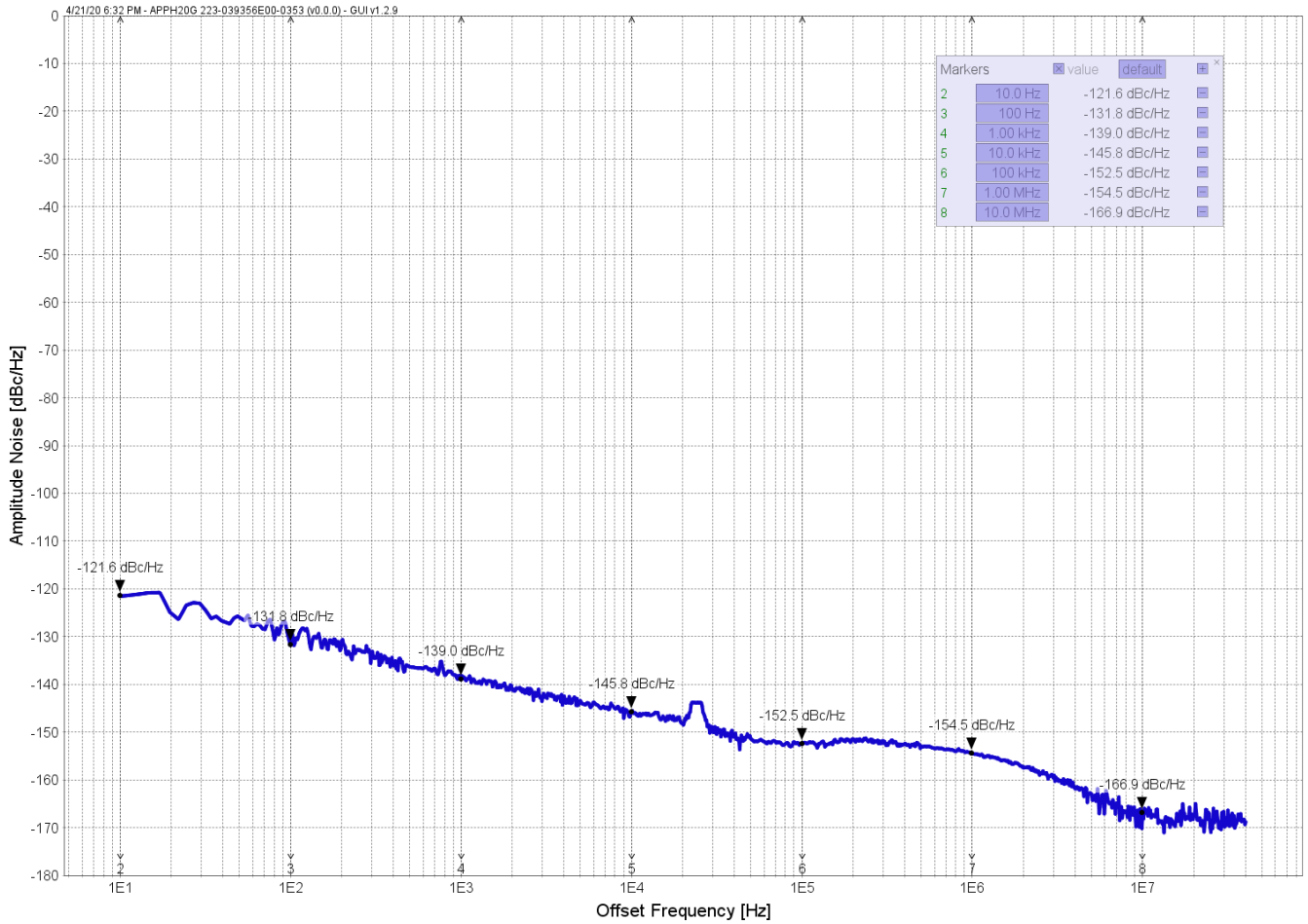
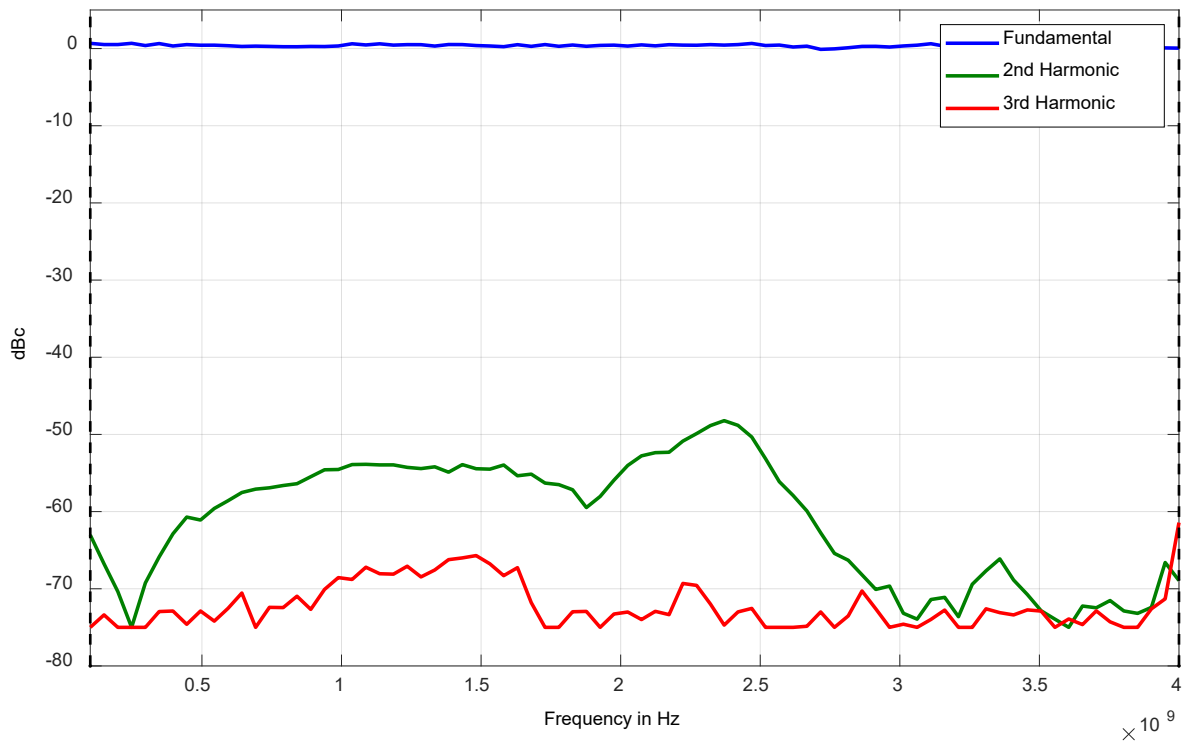
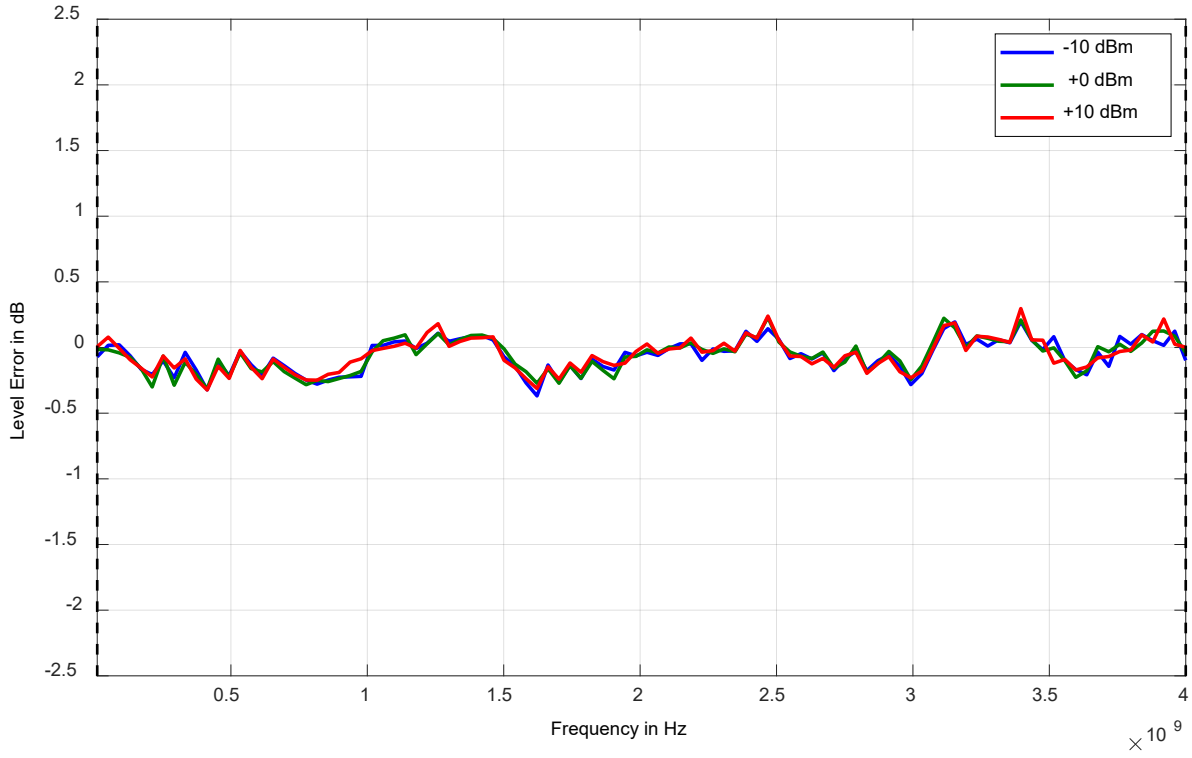

Figure 3: Harmonic performance at 0 dBm



 **Figure 4: Level accuracy**



 64-tone 400 MHz bandwidth signal

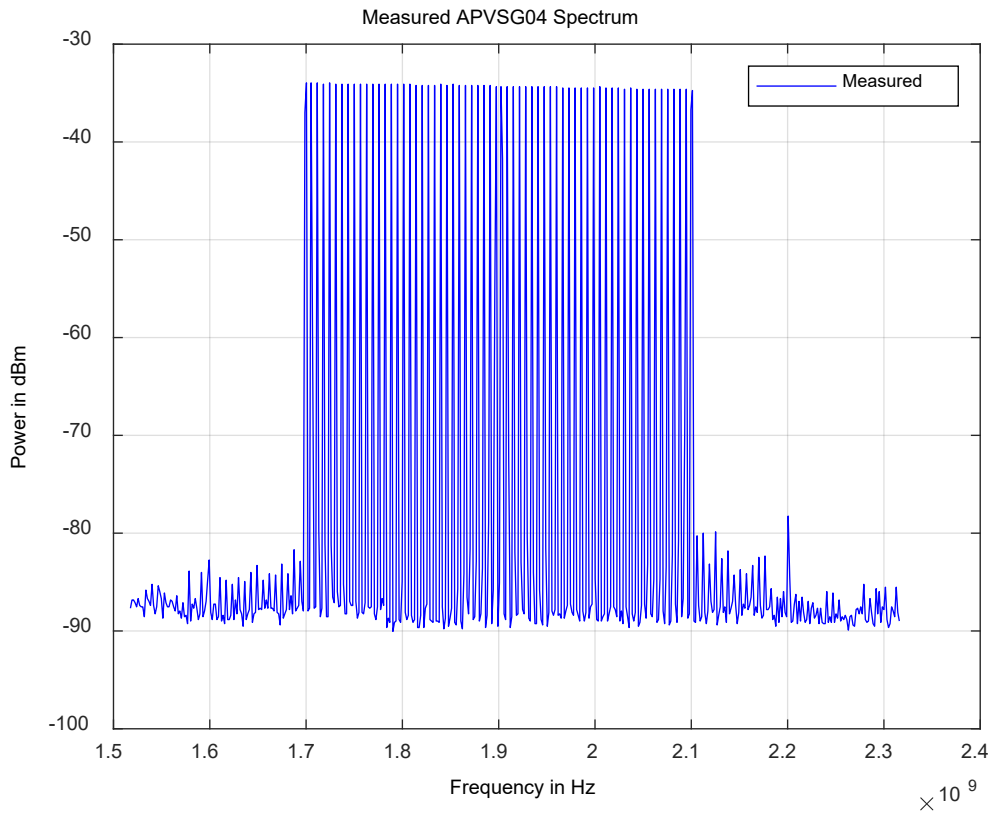

Wideband FM (1MHz rate, 200 MHz deviation)

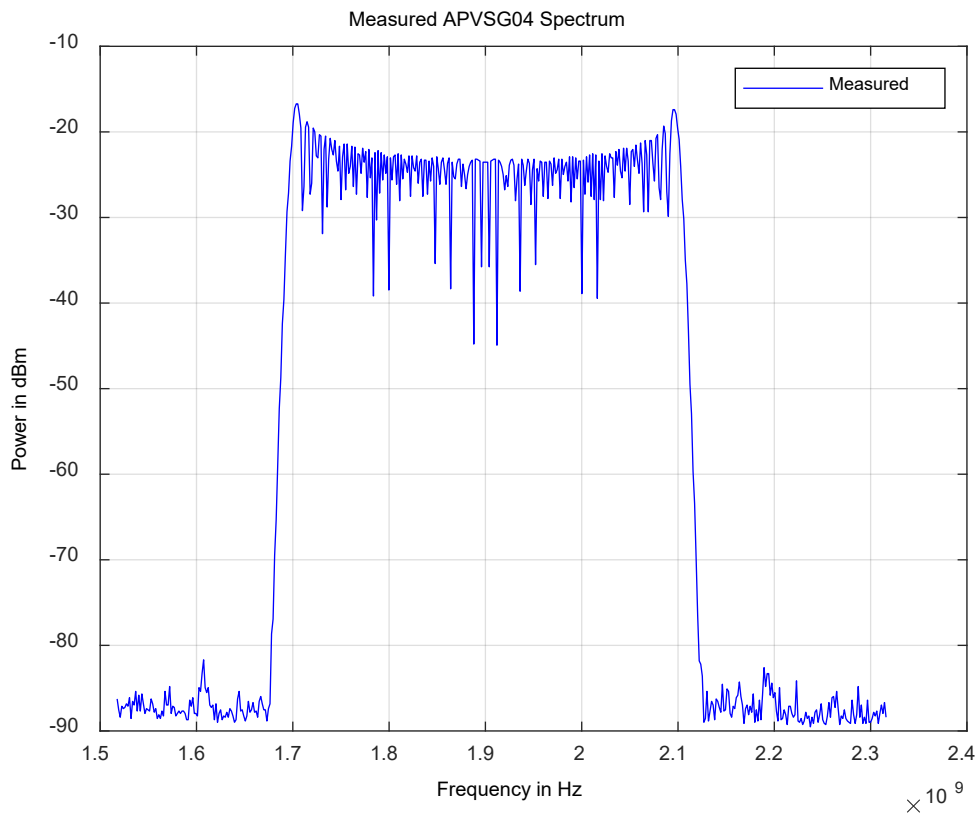

Pulsed chirp (10 microseconds, 400 bandwidth)

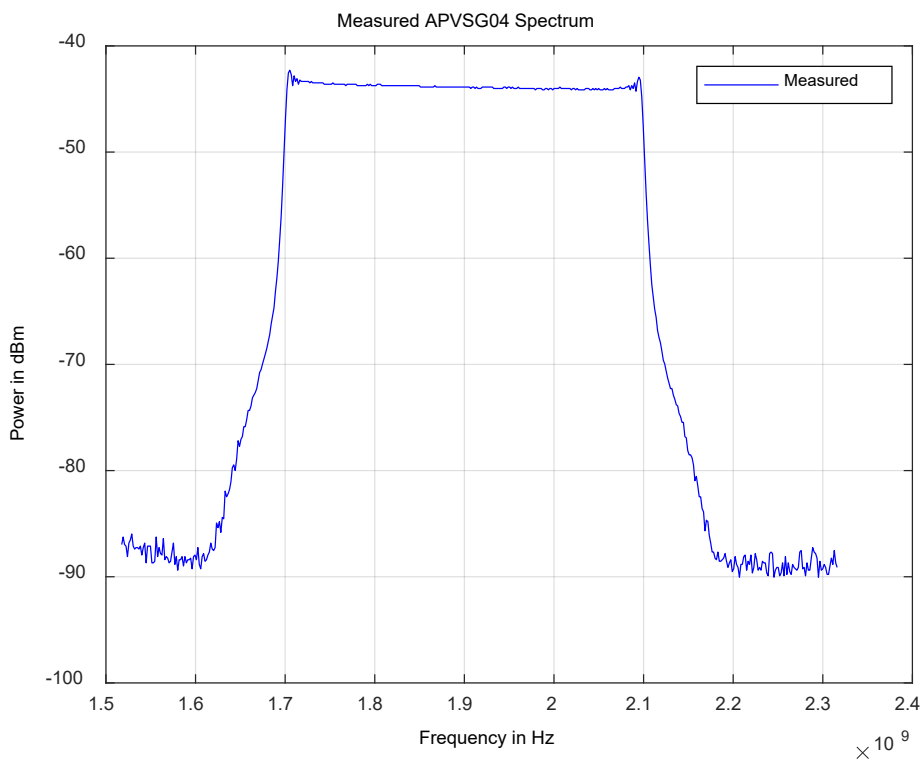

Amplitude modulation (1 kHz rate, 80% depth)

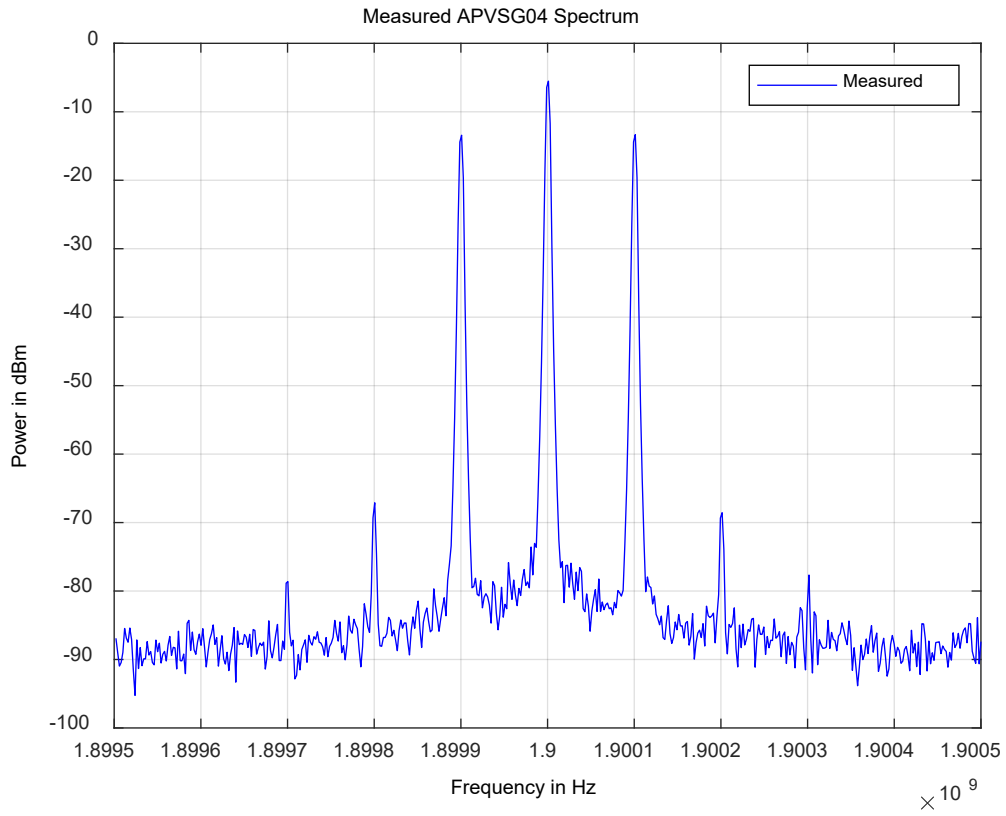

DME Spectrum (X channel, raised cosine filter)

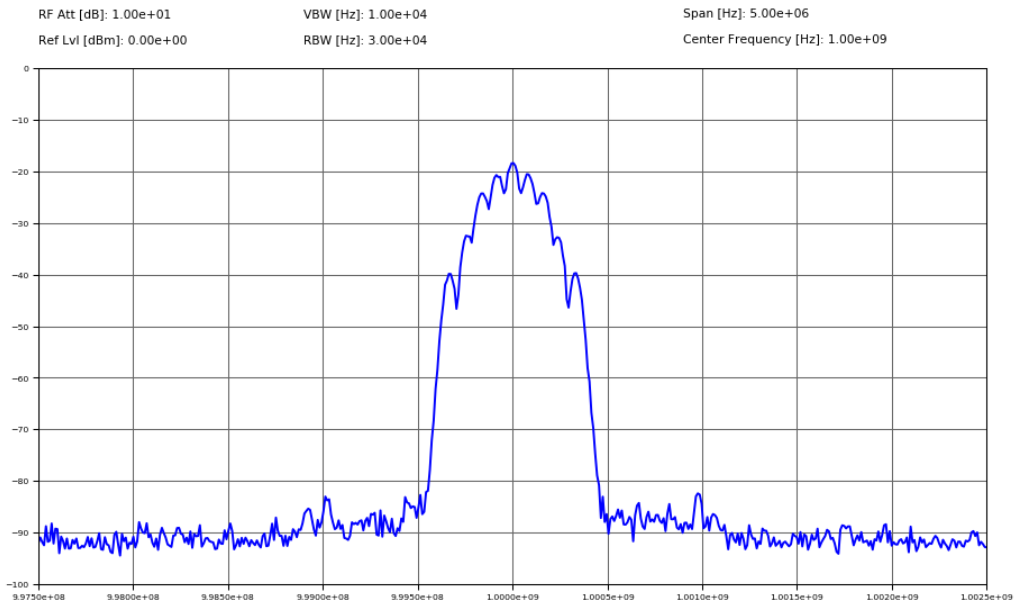

Pulse modulation (10 MHz rate, 10 ns pulse width)

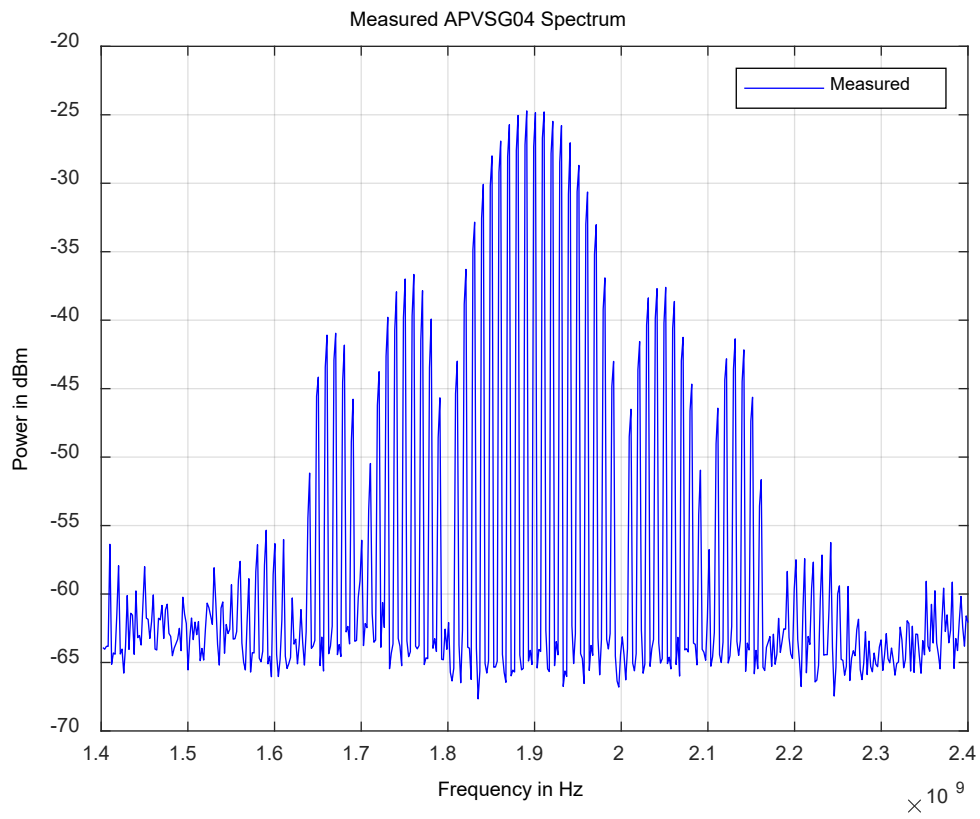

10-tone 500 MHz bandwidth signal

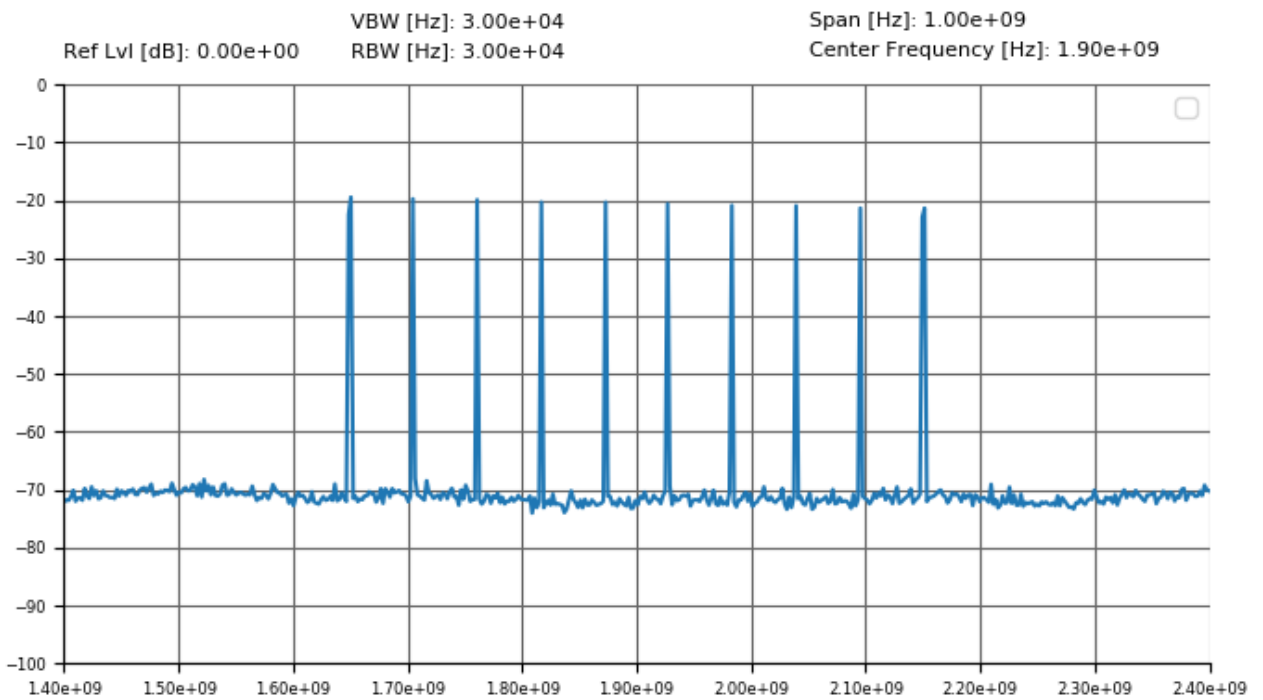



Two-tone sideband rejection

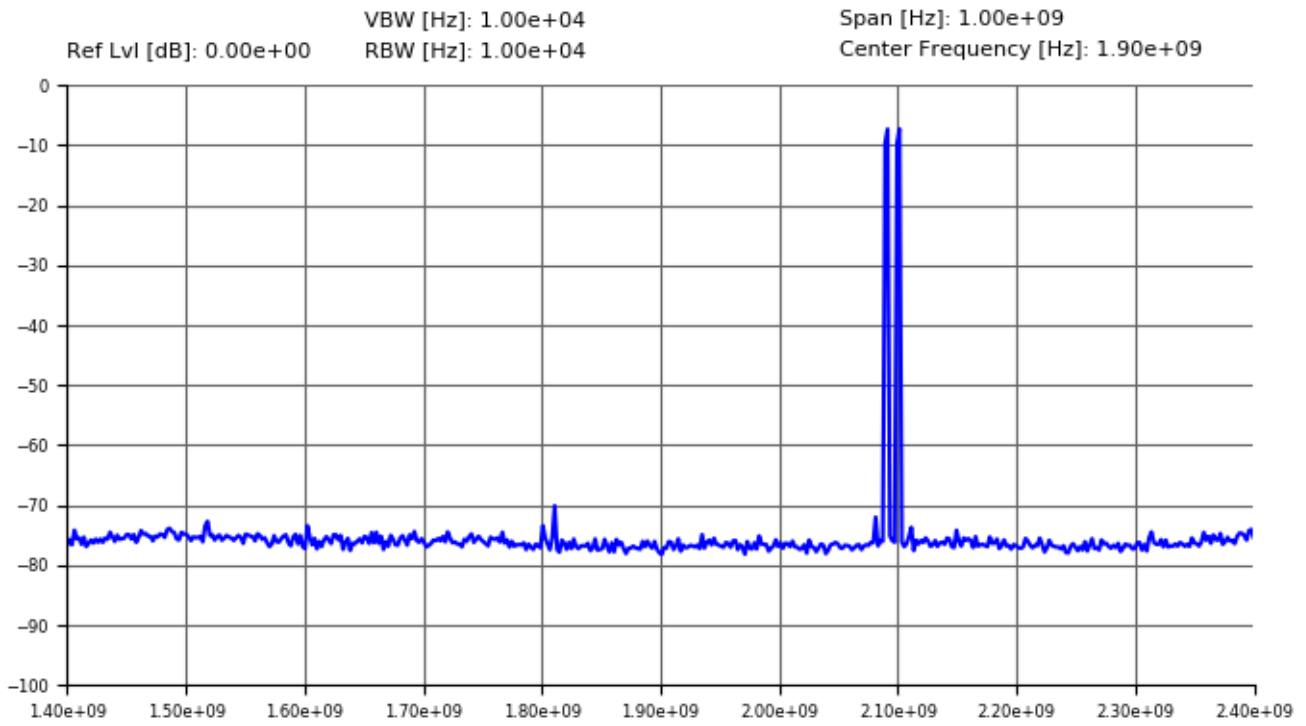

 **Figure 3: Typical VSWR (APVSG04)**

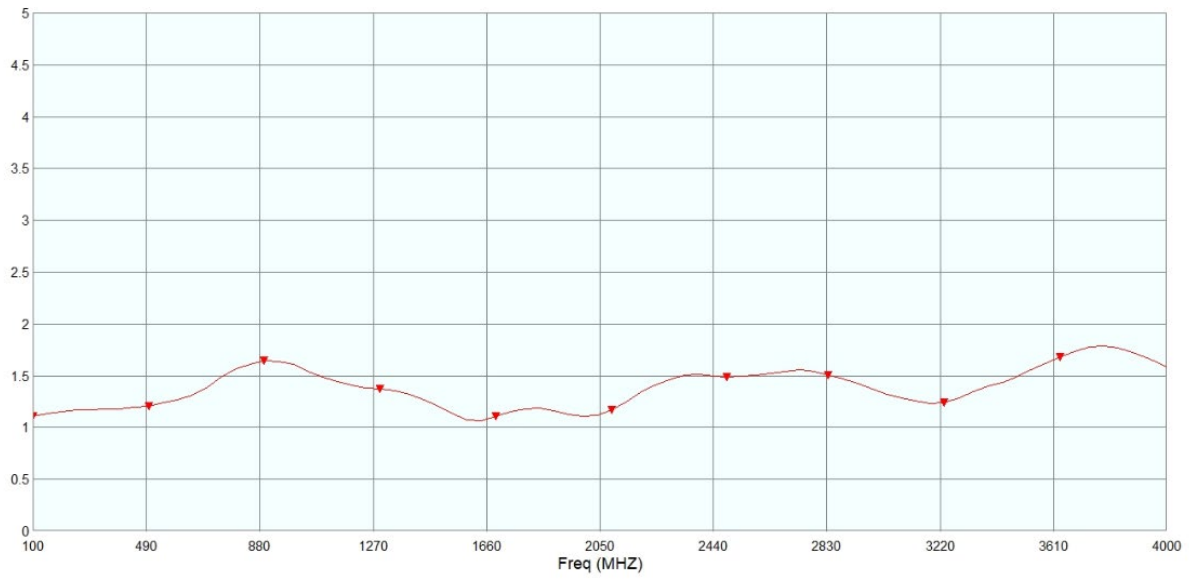

Front panel:

RF output: APVSG04/06/20: SMA female; APVSG40: K (2.92 mm) female



Rear panel:

TRIG 1 IN / I (with option EIQ)	BNC female
TRIG 2 IN	BNC female
TRIG OUT	BNC female
PULSE IN / Q (with option EIQ)	BNC female
FCP	Mini D-type receptacle (optional)
REF IN	BNC female
REF OUT	BNC female
USB	USB B receptacle
LAN	RJ-45 receptacle
GPIB	GPIB receptacle (optional)
DC IN	

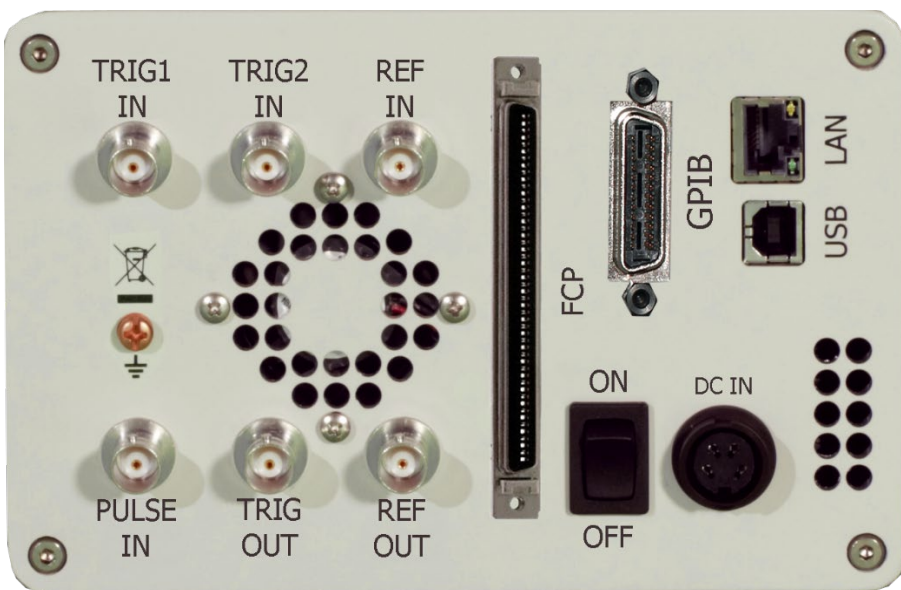

ORDERING INFORMATION



HOST MODEL	PRODUCT	DESCRIPTION
APVSG	APVSG04	4 GHz
APVSG	APVSG06	6 GHz
APVSG	APVSG20	20 GHz
APVSG	APVSG40	40 GHz
APVSG	Option LN	Enhanced close-in phase noise & frequency stability
APVSG	Option UFS	Ultra-fast switching speed
APVSG	Option FCP	Fast control port
APVSG	Option MOD	Analog modulations
APVSG	Option PE4	Electrical step attenuator
APVSG	Option AVIO	Avionic modulations
APVSG	Option VREF	Variable REF input
APVSG	Option EIQ	External analog I/Q Inputs
APVSG	Option WE	One year warranty extension
APVSG	Option ReCal	Recalibration

GENERAL CHARACTERISTICS

Remote programming interfaces

- Ethernet 100BaseT LAN interface,
- USB 2.0 device
- GPIB (IEEE-488.2,1987) with listen and talk (optional)
- Control language SCPI Version 1999.0

Power requirement: 24V ± 3.0 VDC; 25 W max

Mains adapter supplied: 100 -- 240 VAC; 24 VDC and / 2.7 A max

Environmental (Levels similar to MIL-PRF-28800F Class 3/4)

Environmental stress Samples of this product have been type tested to be robust against the environmental stresses of storage, transportation, and end-use; those stresses to temperature, humidity, shock, vibration, altitude, and power line conditions.

Operating temperature range: 0 to 45 °C

Storage temperature range: -40 to 70 °C

Operating and storage altitude up to 15,000 feet (4600 m)



notice

EMC complies to EMC regulations and directives for emission and immunity to interference (EN 61326-1 Industrial, EN/IEC 61326-2-1).

Safety complies to applicable safety regulation IEC/EN 61010-1.

This product complies with directive 2011/65/EU.

Weight: 2.5 kg (6 lbs) net, ≤ 4 kg (8 lb.) shipping

Dimension: 106 mm H x 172 mm W x 290 mm L (incl. connectors) [4.21 in H x 6.77 in W x 11.42 in L]

Recommended calibration cycle: 24 months



Document History

Version/Status	Date	Author	Notes
V110	2019-10-28	jk	Update
V111	2020-02-20	yg/jk	Update
V113	2020-03-31	jk	Analog modulations revised, option EIQ added, measurement plots added
V114	2020-04-31	jk	New plots added

AnaPico Ltd.

Europastrasse 9
8152 Glattbrugg
Switzerland

Phone +41 44 515 55 01
Fax +41 44 440 00 50
Email sales@anapico.com

www.anapico.com
www.anapico.com/downloads/

